

Digmat

The material modeling platform

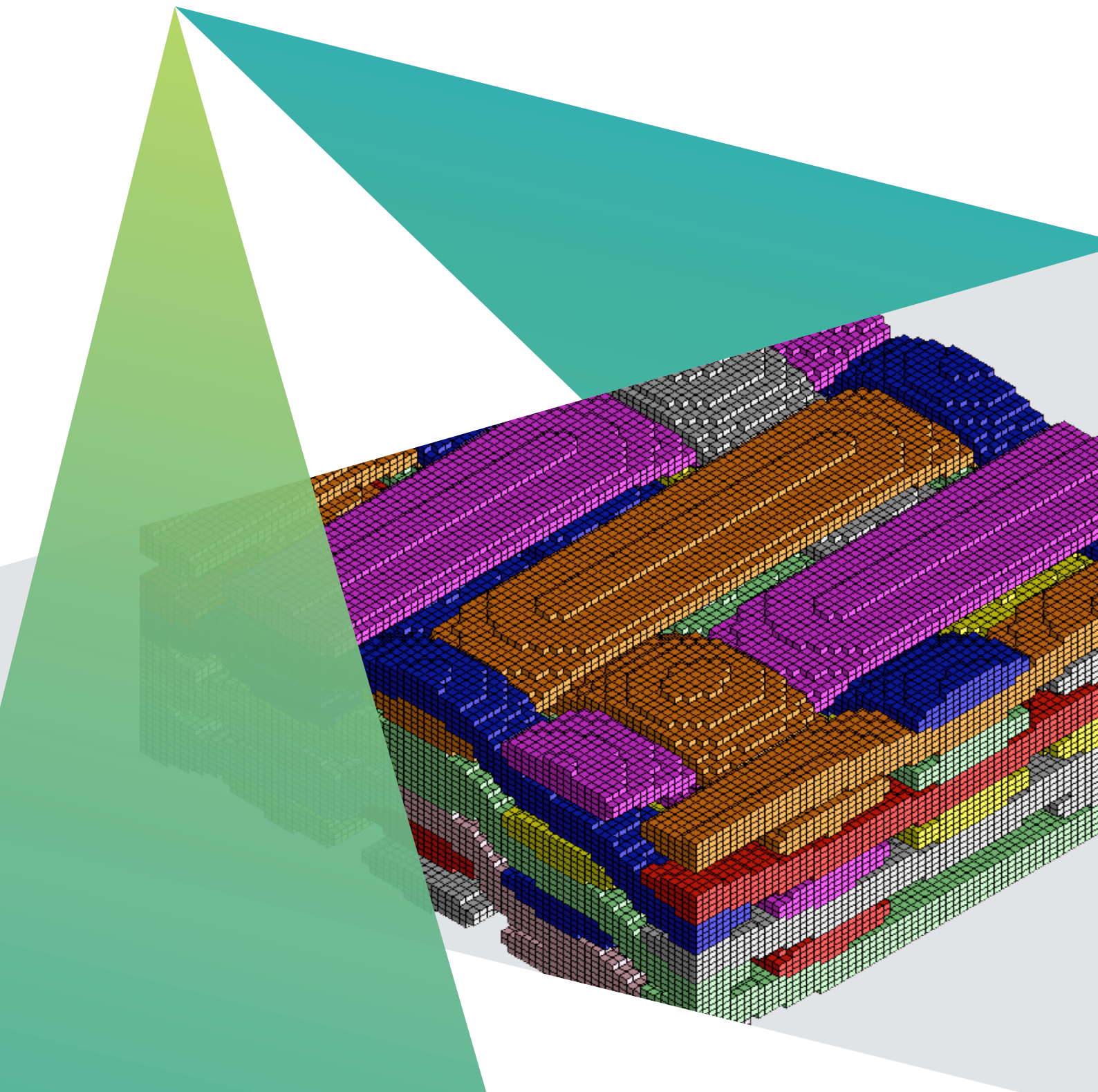

Digmat

e-Xstream engineering develops Digmat, a state-of-the-art multi-scale material modeling technology that helps speed up the development processes for plastic, composite and other heterogeneous materials and structures. Digmat is used by CAE engineers, specialists in manufacturing processes of composite materials, and materials scientists to accurately predict the nonlinear behavior of complex multi-phase composite materials and structures. Digmat, the award-winning software, is relied upon by major Material Suppliers, Tier1s and OEMS worldwide in various industries. It bridges the gap between manufacturing and structural performance. It helps multi-industries using plastics & composites.

Digmat's applications follow three major strategies:

Material Engineering and Virtual Testing

The purpose of material engineering is to take a simulation approach for the identification of promising candidates for new composite materials thereby reducing the amount of experiments needed. This helps to save money and to reduce the time needed to develop new materials.

In research the approach allows to gain insight into and to understand mechanisms that dominate the macroscopic material properties but actually arise from its microscopic composition.

Process Simulation

Digmat provides process simulation solutions for the additive manufacturing of polymers. It helps process engineers to anticipate manufacturing issues and optimize part quality (ex: minimize warpage and residual stresses) by predicting the relative influence of the various process parameters. Digmat also has capabilities allowing to predict curing kinetic and its influence over the material and structural behavior of thermoset composite parts.

Structural Engineering

The purpose of structural engineering is to design full composite parts. The focus is on the part performance as it depends on the material characteristics and the manufacturing method and conditions that were used for the individual design.

Key to this challenge is a material model that correlates to experimental behavior as closely as possible. For this purpose a reverse engineering procedure is used that results in the parametrization of micro-mechanical models and their adaption to a set of anisotropic material measurements to meet the global composite performance best possible.

Such material models can now read locally different micro-structure information from various sources and convert them into a local material property. A fully coupled analysis results in a simulation model with individual material properties described for each integration point in the Finite Element analysis. Coupled analyses are state-of-the-art for the modeling of composite parts and have proven to match experimental observation perfectly on many occasions.

The material modeling platform

e-Xstream's team help engineers, managers and corporations optimize and improve their engineering processes by developing, implementing and customizing tools and solutions as well as consulting on critical projects:

Tools

A complete set of complementary interoperable software products focused on expert usage for material and/or structural engineering.

Solutions

Easy, process-centric, and user-friendly usage of Digmat technology from a fully integrated GUI guided environments for specific tasks (e.g. running coupled analyses for short fiber reinforced plastic parts with Digmat-RP).

eXpertise

Knowledge transfer from 15+ years of experience in micromechanical modeling. It includes a Digmat Users' and Example Manual, as well as access to e-Xstream offers for services, support and trainings. Digmat, furthermore, offers online social platforms to share insights and get updated on recent activities and news.

Award-winning e-Xstream engineering

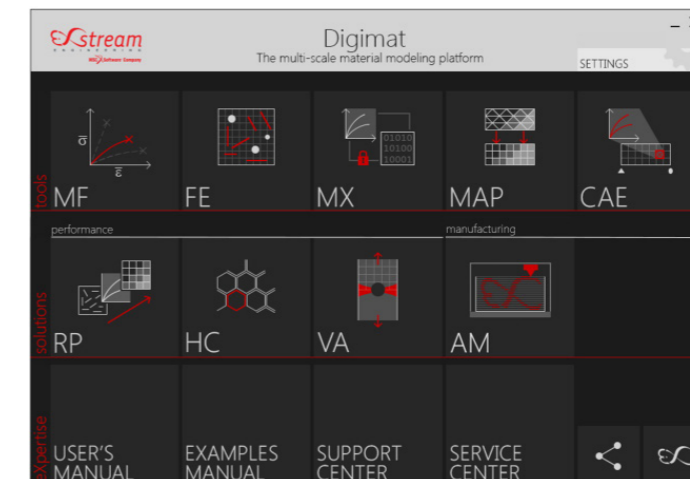
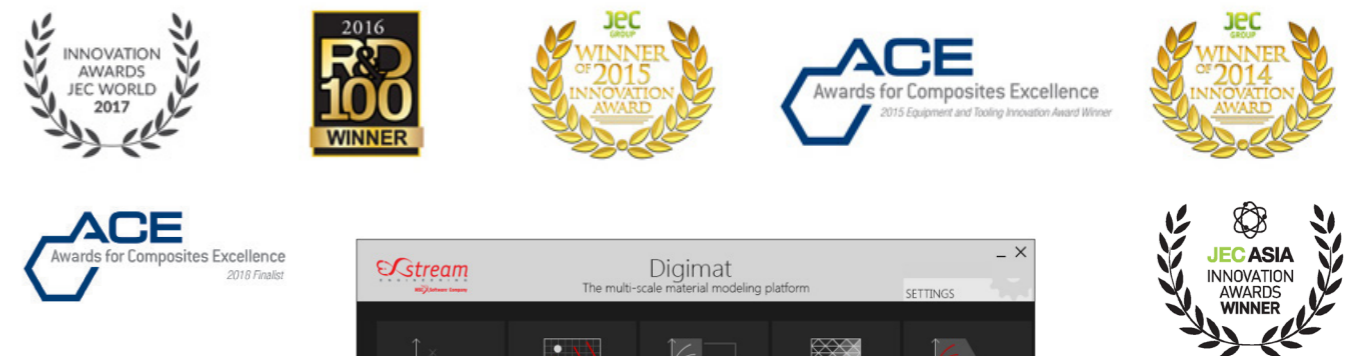

Digmat-MF

Digmat-MF is a mean-field homogenization tool used to rapidly compute the macroscopic performance of composite materials based on their per-phase properties and microstructure definition. Digmat-MF aims at realistically predicting the nonlinear constitutive behavior of multi-phase materials taking into account temperature and strain rate dependencies. The composite morphology such as filler content, length, aspect ratio and orientation take full impact on the resulting composite behavior.

The technology is especially well suited for describing fiber reinforced composites:

- Short fiber reinforced plastics
- Long fiber thermoplastics
- Unidirectional composites
- Woven composites

A broad range of performances can realistically be predicted:

- Stiffness
- Failure
- Creep
- Fatigue
- Conductivity (thermal & electrical)

Nonlinear (per-phase) Material Models

- Linear (Thermo) Elasticity: Isotropic / Transversely isotropic / Orthotropic / Anisotropic
- Linear (Thermo)Viscoelasticity
- (Thermo) Elastoplasticity: J2 Plasticity and Isotropic hardening (Power / Exponential / Exponential laws) or Kinematic hardening (linear with restoration) for cyclic elastoplasticity.
- Pressure dependent elastoplasticity: Drucker-Prager
- Temperature and strain-rate dependent elastoplastic models.
- Elastoplasticity with Damage: Lemaitre-Chaboche
- (Thermo) Elasto-Viscoplasticity: Norton / Power / Prandtl laws
- Viscoelasticity-Viscoplasticity
- Hyperelasticity (finite strain): Neo-Hookean / Mooney-Rivlin / Ogden / Swanson / Storakers (compressible foams)
- Elasto-viscoplasticity (finite strain): Leonov-EGP
- Thermal & electrical conductivity: Ohm & Fourier

Microstructure Morphology

- Multiple reinforcement phases
- Multi-layer microstructure
- Ellipsoidal reinforcements (fillers, fibers, platelets)
- Aspect ratio distribution
- General orientation (fixed, random, 2nd order orientation tensor)
- Void inclusions
- Coated inclusions with relative or absolute thickness
- Deformable, quasi-rigid or rigid inclusions
- Clustering

Homogenization Methods

- Mori-Tanaka
- Interpolative double inclusion
- 1st and 2nd order homogenization schemes
- Multi-step, multi-level homogenization methods

Failure Indicators

- Applied at micro and/or macro scale, or on pseudo-grains using the FPGF model (First Pseudo-Grain Failure model), including multilayer failure controls
- Failure models: Maximum stress and strain, Tsai-Hill 2D, 3D & 3D Transversely Isotropic, Azzi- Tsai-Hill 2D, Tsai-Wu 2D, 3D & 3D Transversely Isotropic, Hashin-Rotem 2D, Hashin 2D & 3D, SIFT, Christensen, User-defined
- Strain rate dependent failure criteria
- Failure criteria on Leonov-EGP & hyperelastic material models

Progressive Failure

- Failure: Hashin 2D / Hashin 3D / Hashin-Rotem 2D/ Multicomponent 2D
- Damage: Matzenmiller / Lubliner / Taylor (MLT) / Individual damage evolution functions
- Stabilization control using viscous regularization

Fatigue

- Pseudo-grain based fatigue model specifically for short fiber reinforced plastics
- Matrix damage based fatigue model for unidirectional composites Pseudo-grain based fatigue model specifically

Loading

- Monotonic, cyclic or user-defined history loading
- Multi-axial stress or strain, General 2D & 3D, Harmonic
- Mechanical and thermo-mechanical
- Prediction of thermal & electrical conductivities

Further functionalities:

- Prediction of orthotropic engineering constants
- User defined outputs
- Interoperability with Digmat-FE and Digmat-MX
- Handling of encrypted material files

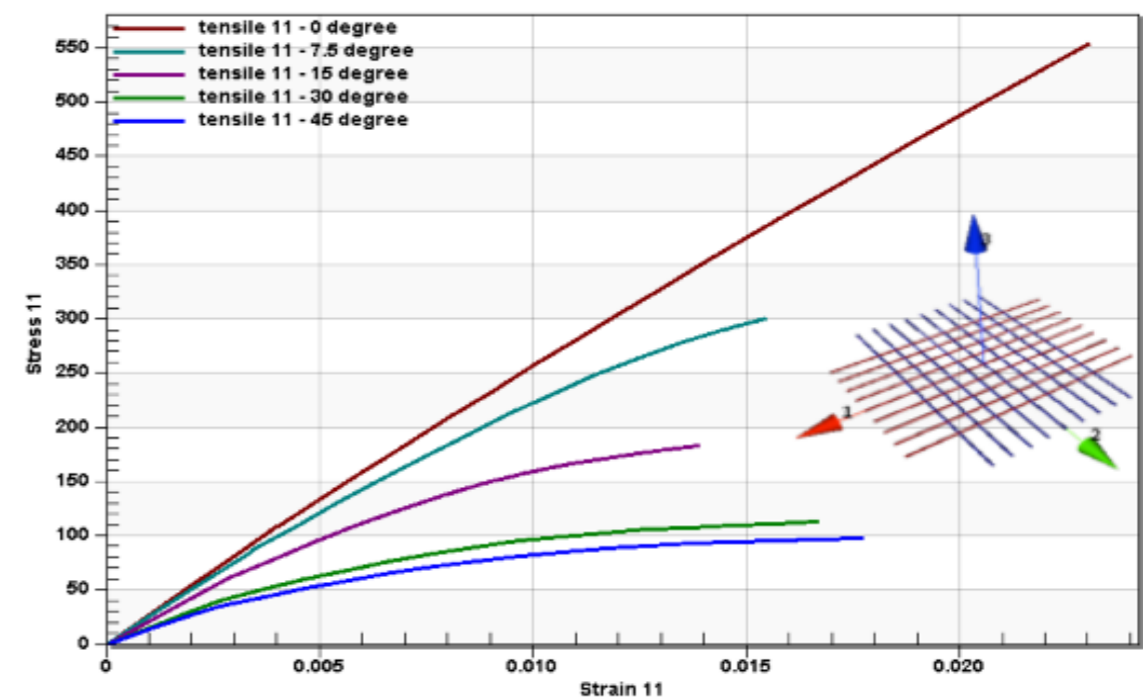

Stiffness & failure of thermoplastics based woven composites dependent of the fiber orientation

Digmat-FE

Digmat-FE is the tool performing computational homogenization, starting at microscopic scale in order to gain an in-depth view into the composite material by the direct investigation of Representative Volume Elements (RVEs). Digmat-FE can act as a stochastic generator of highly realistic RVEs covering a large variety of materials: plastics, rubbers, metals, ceramics, nano-filled materials. It also allows importing microstructure from geometry files (e.g. STL files) or 3D image files (e.g. RAW file), or to manually import single inclusion geometry and position them within the RVE.

Based on material input and the microstructure definition, a finite element model is built and submitted to analysis. The results of the FE analysis are post-processed by using probabilistic distribution functions that give detailed insight into the RVE. Mean homogenized values are computed and can be used in subsequent FE analysis on the structural part level.

Digmat-FE allows to solve the problem at-hand over the RVE using internal Finite Element of FFT/spectral solvers, or to export corresponding finite element models.

End-to-end solution

A complete end-to-end solution has been implemented in Digmat. It allows performing all the different steps needed to obtain a complete FE analysis - starting from the material data. For instance, the steps followed to model woven composites are:

- Extraction of the material data from the datasheet
- Mean-field homogenization of the yarns
- Generation of a geometry of a unit cell
- Generation of a RVE
- Voxelisation
- FE model definition and application of periodic boundary conditions
- Solving the FE analysis
- Post-processing the outputs of the FE analysis

Latest Capabilities

- New microstructures
 - Foams: open and closed cells (random or periodic)
 - Polycrystalline materials
 - Lattices
 - Imported from STL geometry or RAW images files

Main Capabilities

- Definition of composite constituents
- Inclusion shapes (Spheroid, Platelet, Ellipsoid, Cylinder, Curvy fibers, User defined, etc.)
- Material models (Elastic, (Thermo) Elastic, (Thermo) Elastoplastic, Viscoelastic, etc.)
- Inter-operability with Digmat-MF and Digmat-MX

- User defined failure indicator
- Custom weave pattern for woven 3D

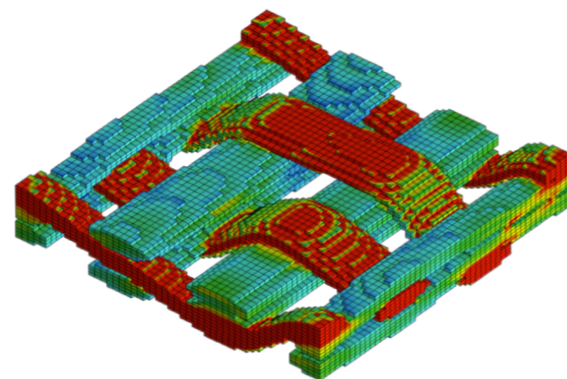

Voxel based solution for a woven 2.5D composite material computed in Digmat-FE

Microstructure Definition

- Predefined phase types: matrix, inclusion, continuous fiber, void, yarn, strand, grain
- Microstructure morphology definition: Volume /Mass fraction
- Multiple inclusion shapes
- General orientation definition (fixed, random, 2nd order orientation tensor, from EBSD/ODF data for polycrystalline materials)
- Fiber length or grain size with access to size distribution
- Coating
- Inclusion / Matrix debonding
- Multi-layer microstructure
- Predefined microstructures: generic, fabrics, lattices, foams, polycrystalline metals, cemented metals.
- Imported from STL geometry or 3D RAW image files.

RVE Generation

- RVE microstructure generation with real-time preview & animation process
- Random positioning, maximum packing or random perturbation algorithms
- 3D & 2D RVEs
- Unit cell generation.

FE Meshing

- Voxel and conforming internal mesher available for FE/ Solver
- Grid generation for FFT/Spectral solver
- Export finite element models to : Marc, Abaqus/ Standard, Ansys and LS-Dyna.
- RVE meshing embedded beam elements, straight or curved

RVE Analysis

- Monotonic / Cyclic / User-defined history loadings
- Multi-axial stress or strain, General 2D & 3D
- Mechanical and thermo-mechanical
- Computation of the percolation threshold
- Prediction of thermal and electrical conductivities
- Loading definition from structural FEA, i.e. Abaqus ODB file, Marc t16 file
- Export of RVE geometry in common formats: STEP, IGES, BREP

Embedded solver

- Digmat-FE solvers for end-to-end solution
 - Finite element solver with CPU based parallelization.
 - Spectral solver with CPU & GPU based parallelization.
- FE analysis can be started & monitored from within Digmat-FE

Post-Processing

- Field visualization of results over RVE
- Computation & visualization of resultant distributions over RVE
- Computation of representative (mean) properties

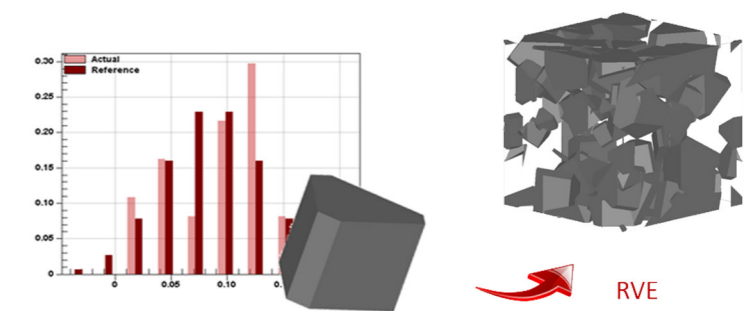

Generation of complex RVE based on geometric shape & size distribution

Digmat-MX

Digmat-MX is an eXchange tool that allows the user to reverse engineer, store, retrieve and securely share micromechanical models between material experts and designers of composite parts.

Digmat-MX tool stores anisotropic measurements and related micromechanical models. Embedded parameterization tools allow you to adapt the material performance to experimental data. Resulting Digmat models can be shared within large communities of different users. Intellectual property is assured by built-in encryption technology.

Digmat-MX comes along with:

Public Data

- Ready-to-run Digmat material models
- Experimental data as a base for building Digmat material models
- Database setup & tools:
 - Flexible user/group scenarios
- Data import & reverse engineering of Digmat material models
- Encryption technology for secured sharing

Latest Capabilities

- New filtering experience
- Automatic reverse-engineering of material model parameters for SFRP from data-sheet information
- Validation of calibrated material model parameters using finite elements models of dumbbells
- Enhanced SFRP fatigue reverse engineering
- Support of failure multilayer trigger
- Support of any loading angle
- Stress localization factor computation
- Public Database new content: Asahi Kasei, Borealis, DSM, Dupont, Kuraray, Sabic, Domo, Solvay Specialty Polymers, Stratasy Inc., Sumika Polymer Compounds, Evonik, Avient, Radici, PolyOne, Ascend, Kolon plastics, Toray, MarkForged, Hankuk Carbon, Mitsui Chemicals & LG chemicals.
- From e-Xstream: generic grade (chopped fiber and continuous fiber)
- Given access to:
 - Experimental data (tensile)
 - Digmat material / analysis files for homogeneous / composite materials: chopped fibers (short, long), continuous fibers (woven, unidirectional)
- Data available under various conditions:
 - Temperature, relative humidity, strain rates & loading angles
- Import, Filter & Reverse Engineering tools

Main Capabilities

Material database

- Public data:
 - From material suppliers: AGATE, Asahi Kasei, Borealis, Dupont, DSM, EMS-GRIVORY, EVONIK, Kuraray, LyonDellBasell, NCAMP, Radici, SABIC, Domo Engineering Plastics, Solvay SP, Stratasy Inc, Sumitomo, Sumika Polymer Compounds Celanese, Trinseo, Victrex, Avient, PolyOne, Ascend, Kolon plastics, Toray, MarkForged, Hankuk Carbon, Mitsui Chemicals & LG chemicals.

Database content	Private	Shared	Public	Total
Grades	1	0	101	102
Digmat Analysis	2	0	4802	4804
Digmat Material	0	0	1	1
Experimental Data	4	0	182	186

Public data for Short fiber reinforced plastics and UD & woven composites

Parametric identification

- Identify material model parameters based on the homogeneous material responses
 - Can be done on one or several curves at the same time

Encryption

- Material files can be encrypted for confidentiality purposes (available in MX+)
- Encrypted files can be used in Digmat-MF, Digmat-RP, Digmat-AM and Digmat-CAE, the material parameters being hidden
- Encrypted material files can be attributed an expiration date (available in MX+)

Additional Digmat-MX tools

- Data sheet generation of Digmat material models, as well as of experimental files, in pdf format.
- Database summary

Reverse Engineering

Two methods are available: automatic for easy and efficient reverse engineering, and interactive for expert reverse engineering.

- Automatic reverse engineering
 - Linear elasticity, J2-plasticity, FPGF failure
- Available for SFRP (glass fiber)

- Requires at least 2 stress-strain curves
- Available for CFRP (glass and carbon fiber)
 - Linear elasticity, PFA
 - Requires basic datasheet information
- Interactive reverse engineering
- Various loading angles, strain rates and / or temperatures
- At homogeneous and macroscopic level
- Material models that can be reverse engineered:
 - (Thermo) Elastic
 - Viscoelastic
 - (Thermo) Elastoplastic
 - (Thermo) Elasto-viscoplastic
 - Viscoelastic-viscoplastic
- Failure indicators that can be reverse engineered:
 - Maximum stress, maximum strain
 - Tsai-Hill 2D, Tsai-Hill 2D in strain
 - Tsai-Wu 2D, Tsai-Wu 2D in strain
 - Hashin Rotem 2D
 - Hashin 2D
 - Tsai-Hill 3D transversely isotropic
 - Tsai-Wu 3D transversely isotropic
 - SFRP pseudo-grain fatigue
- Other features that can be reverse engineered:
 - Aspect ratio of inclusion phase
- Multi-layer microstructures are supported
- Localization factor computation through FEA for more accurate material models for static and fatigue performances calibration.
- FEA for validation of calibrated material models over coupon

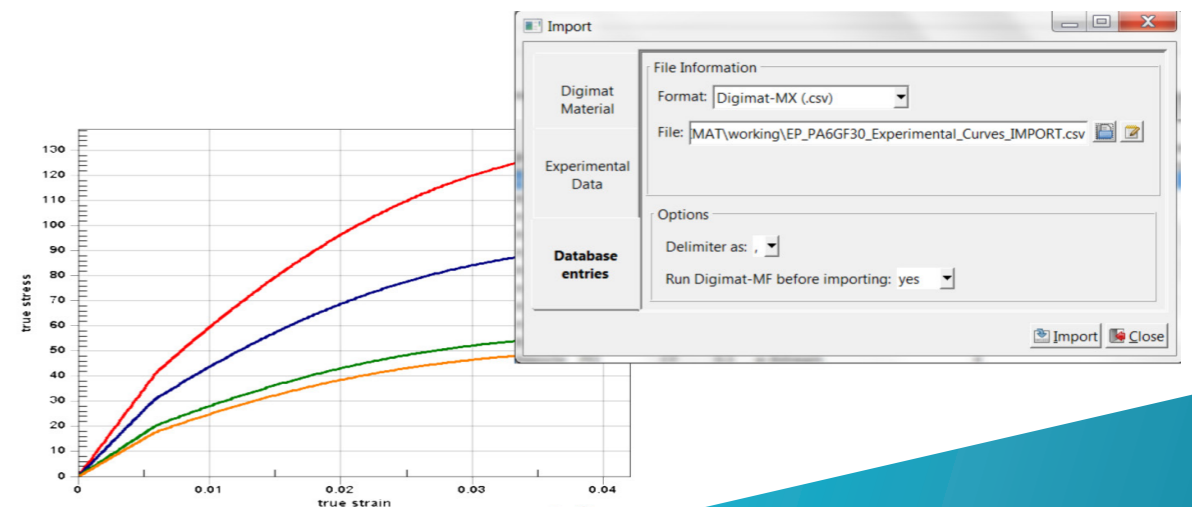

Digmat-MAP

Digmat-MAP is a highly efficient mapping software used to transfer data between dissimilar meshes. A rich set of embedded tools allows full control over the required workflows:

Manipulation of meshes

- Measurement of positions, distances, and angles
- Manual superposition
- Automated superposition

Transfer of data

- Fiber orientation, volume fraction & aspect ratio
- Temperature
- Residual stresses
- Location of weld lines

Quality Assessment

- Global & local error analysis

Visualization & Post-Processing

- Display of mapped microstructure (scalar, tensor vector & ellipsoidal plot)
- Investigation of local stiffness

Latest Capabilities

- Extended molding data support
 - Cadmould
- Support of porosity data from Volume Graphics (diffuse and macroscopic porosities)
- New partial infill field mapping for FFF and FDM processes, starting from toolpath
- Support of CFF process for MarkForged printers
- New mesh extrusion capability used when mapping data from Aniform meshes

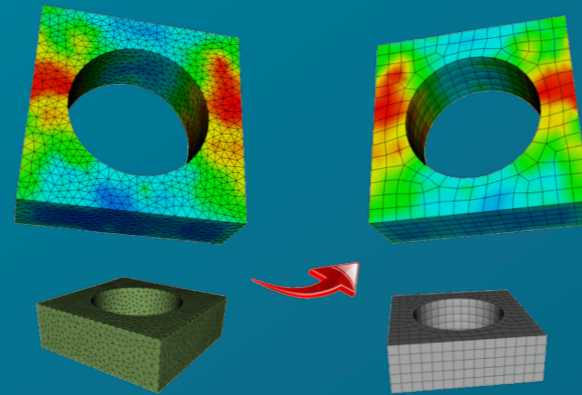

Mapping of data between dissimilar meshes

Main Capabilities

Data Types Managed

- Fiber orientation: Orientation tensor / Woven (warp / weft)
- Fiber length: Aspect ratio
- Volume fraction: Fibers / Voids
- Residual stresses
- Temperatures
- Weld Lines
- Thickness
- Warpage
- Toolpath Element sets

Element types

- Donor
 - Tetrahedron or triangular shell elements
 - Hexahedron and wedge elements
- Receiver
 - Tetrahedron or triangular shell elements
 - Hexahedron or quadrangular shell elements
 - Wedge elements

Shell & 3D Mapping

- From midplane to multi-layered shell
- Between Continuum 3D elements
- Across the shell thickness
- 3D to shell mapping

Data Post-Processing

- Contour or vector plots
- Display tensorial fields using ellipsoids
- Synchronized display of donor and receiving meshes
- Through-the-thickness orientation or temperature plot for shell elements
- Cut plane on 3D meshes
- Superposition display of the donor with the receiving meshes

Error Indicators

- Global & local error indicators to validate mapping quality

Donor-Receiver Positioning

- Scaling, Translation, Rotation, Superposition

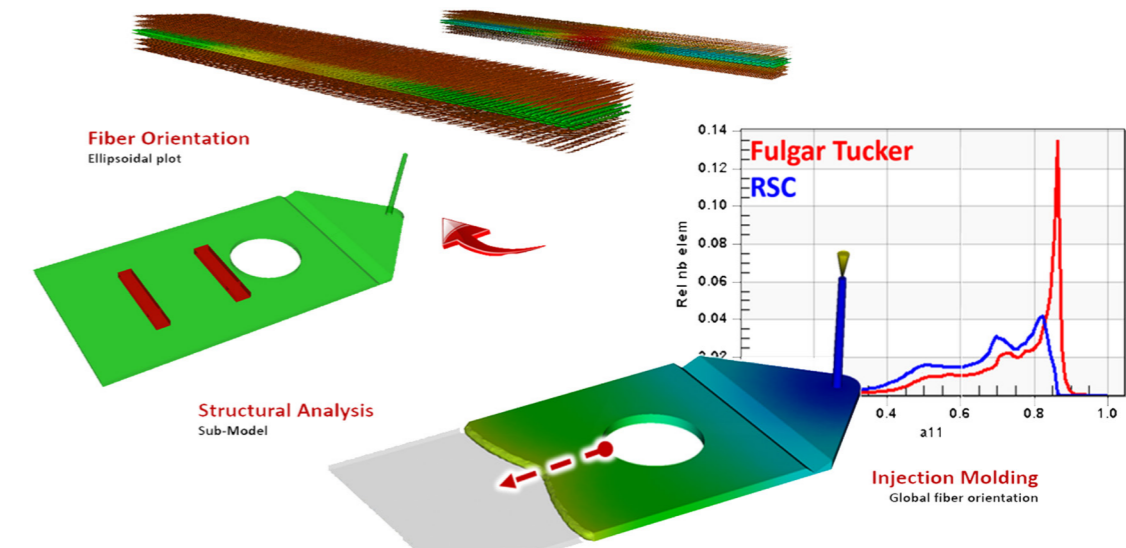

Local visualization and global analysis of fiber orientation data after mapping

Digmat-CAE

Digmat-CAE centralizes the upstream and downstream interfaces for Digmat material models and bridges the gap between processing and final composite part performance.

It is the central tool used for building coupled multi-scale analyses based on the manufacturing process.

Local microstructure is taken into account and translated into a macroscopic material response. This results in a highly accurate prediction of the final performance of the composite part.

Digmat-CAE offers GUI guidance for the set-up of integrative simulations and supports this approach via embedded Plug-Ins in native FEA environments. Choices of Digmat multi-scale solution methods (MACRO/MICRO/HYBRID) allows the individual to balance the need for accuracy and fast computation.

Latest Capabilities

- Addition of a temperature and strain-rate dependent elastoplastic model.
- Support of thermo-mechanical analysis for LS-DYNA/Implicit.
- Support of advance PFA model for structural analysis.
- Support of structural curing analysis.

CAE interface maintenance

- Abaqus: 2018, 2019, 2020 (several sub-versions)
- ANSYS: 2019, 2020 (several sub-versions)
- LS-DYNA: 9.3, 10.2, 11.1
- Marc: 2018.1, 2019, 2020
- Permas : 18
- Nastran SOL1XX: 2019 or older
- PAM-CRASH: 2017, 2018, 2019
- Samcef: V16, V17
- nCode: 2018.1, 2020, 2020.1
-



Anisotropic multi-scale material modeling for accurate design simulations

Post-Processing

- Micro
 - Default & customized material output
 - Design output related to the fiber orientation
- Hybrid
 - Reduced number of material output
 - Design output related to the fiber orientation

Digmat-CAE/Structural

- FEA solver types:
 - Explicit
 - Implicit
- Micromechanical Material Model:
 - Linear
 - Nonlinear
 - Rate dependent
 - Thermo dependent
 - Finite strain
- Weak coupling/ Macro solution

- Hybrid:
 - E, EP, EVP, TE, TEP, TEVP, VE, V EVP material
 - Standard per phase failure and FPGF at the composite level - except for TE/TEP
 - Short fiber, UD, Woven
- Strong coupling interfaces to FEA:
 - Abaqus Standard & Explicit
 - ANSYS Mechanical
 - LS-DYNA, Implicit & Explicit
 - Marc
 - Nastran SOL400
 - PAM-CRASH
 - SAMCEF (Mecano / Dynam)

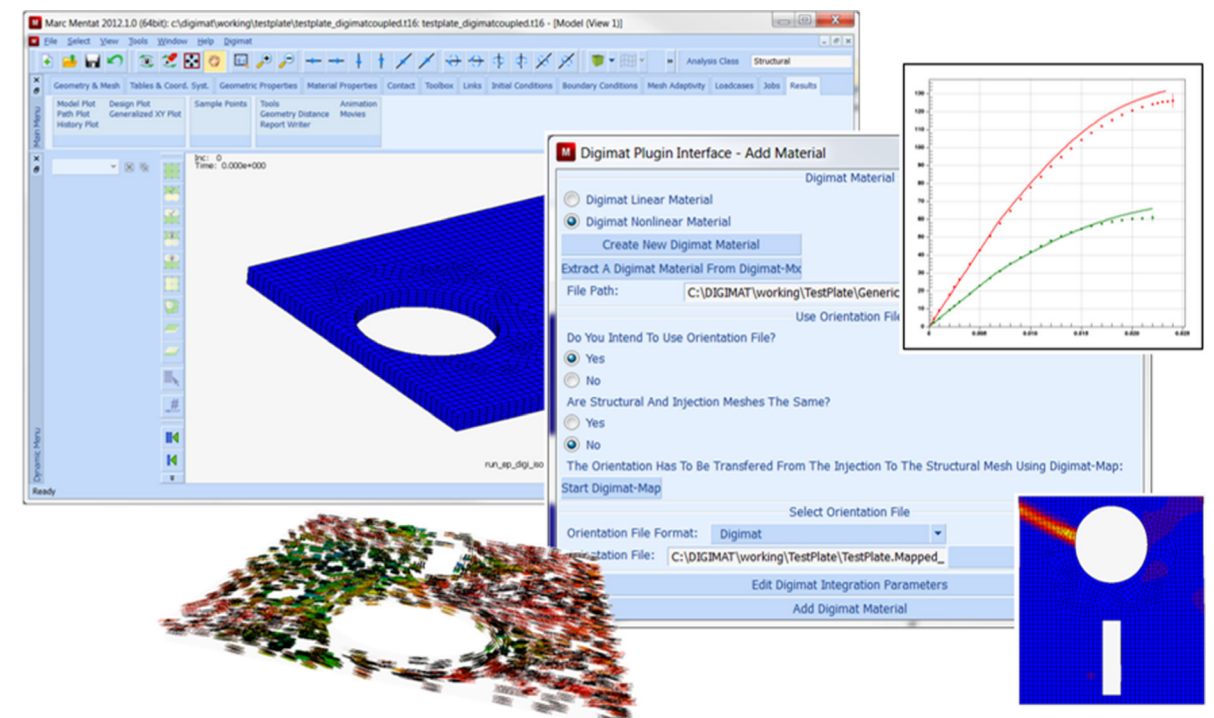

User-friendly Digmat plug-ins into native CAE environments

Digmat-RP

Digmat-RP is a solution for the virtual design of injection molded fiber reinforced plastic parts. Lightweight engineering re-designs metal parts into fiber reinforced plastics produced by injection molding. For reinforced plastics manufacturing procedures influence the material microstructure. The effect of local fiber orientation leads to a distribution of material properties over the part. This can drastically influence its final performance and must be taken into account in the design procedures.

Multi-scale simulations read local fiber orientations from injection molding simulations and feed them into a micromechanical material model. The distribution of local properties is taken into account in the computation of the final performance of the part.

Digmat-RP allows to:

- Load finite element analyses of a broad range of different solvers
- Assign a micromechanical material model to a specific part
- Choose a robust & fast multi-scale simulation method for a coupled analysis
- Map local microstructure information onto the part
- Estimate microstructure if no manufacturing data is available yet
- Launch & monitor the coupled analysis
- Access the results of the multi-scale simulation

Latest Capabilities

- Support of command-line mode.
- Extended Digmat-RP/Moldex3D solver interface for valve gate control
- New fatigue post-processing environment
- Support of fiber reinforced FFF/FDM/SLS materials
- Supported partial infill microstructure in FFF/FDM
- Extended microstructure estimation
 - 3D mesh: weld line location
 - New 2D mesh support for fiber orientation estimation

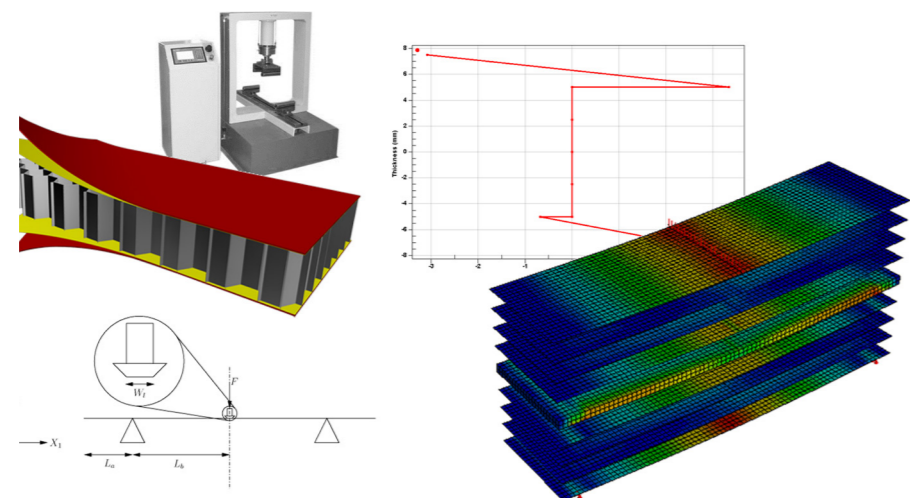

Bridging the gap between injection molding and structural simulations

Main Capabilities

- Easy setup of 3D & shell coupled analyses
- Processing
 - Microstructure estimation with Digmat-RP/ Moldex3D add-on
 - Injection / Injection-Compression / Compression molding Software / Additive Manufacturing
 - Moldflow
 - Moldex3D
 - Sigmasoft
 - 3DTimon
 - REM3D
 - SIMPOE
 - Digmat-AM
 - Stratasys/Insight
 - MarkForged
- Material
 - 2-phase materials
 - Short & long fiber reinforced polymers (Molding), Unfilled & reinforced polymers (Additive manufacturing)
 - Input
 - Generic
 - From Digmat-MX (Support of encryption)
 - From Digmat-MF (From File (.daf & .mat))
- FEM solvers
 - Marc
 - MSC Nastran (SOL 1XX, SOL400 and SOL700)
 - Abaqus (Standard & Explicit)
 - Ansys
 - LS-Dyna (Implicit & Explicit)
 - Optistruct
 - PERMAS
 - Samcef
 - Pam-Crash
- Solution methods:
 - Macro, Micro, Hybrid, Linear
 - User defined templates
- Job management
 - Submission
 - Monitoring

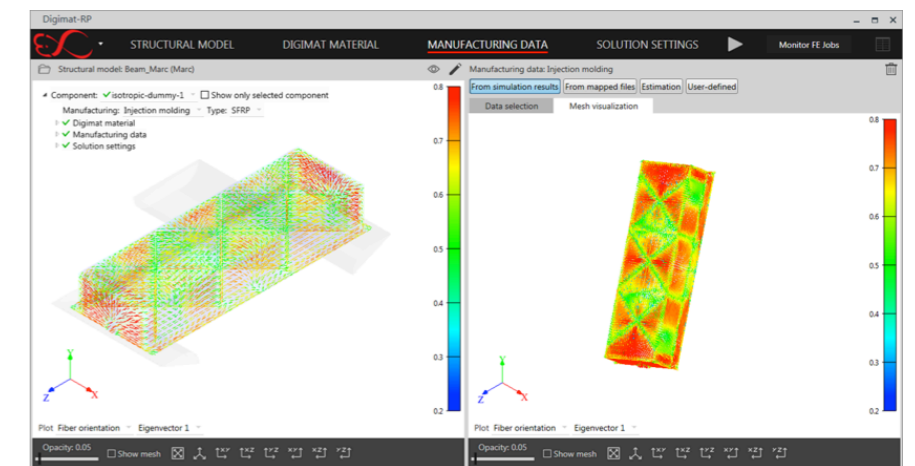

User-friendly setup of multi-scale analyses in Digmat-RP

Digmat-HC

Digmat-HC is the solution for the virtual design of honeycomb composite sandwich panels.

The performance of composite sandwich panels depends on the properties of the skin and the core. These are determined by the choice of the underlying microstructure. The core is sensitive to the structure of the constituting honeycomb. The composite skins performance is dependent on the selected fiber type and stacking orientation of the layers. Design choices are typically investigated in bending and shear tests.

The virtual design of a composite sandwich panel requires a multi-scale modeling strategy to be able to map the effect of the microstructure onto the macroscopic performance of the panel. In a coupled analysis the full setup of the panel can be varied and the impact on the final performance under bending and shear investigated in an easy & efficient way.

Digmat-HC allows the user to:

- Set up the structure of a composite sandwich panel
- Define the properties of the core (honeycomb & foam)
- Define the properties of the skins (UD, woven, & chopped fibers)
- Investigate the panel design under different scenarios (3-/4-point-bending & shear)
- Flexible access to the results of the analysis (field plot & through-thickness path analysis)

Main capabilities

Skin Definition

- Pile up:
 - Symmetric
 - Anti-symmetric
- Material properties:
 - Orthotropic elastic properties of the ply
 - Ply orientation
- Resin/Fibers:
 - Isotropic elastic properties of the resin and fibers
 - Fiber weight fraction, length and orientation

The equivalent, homogenous, properties of the skins are computed using micromechanics.

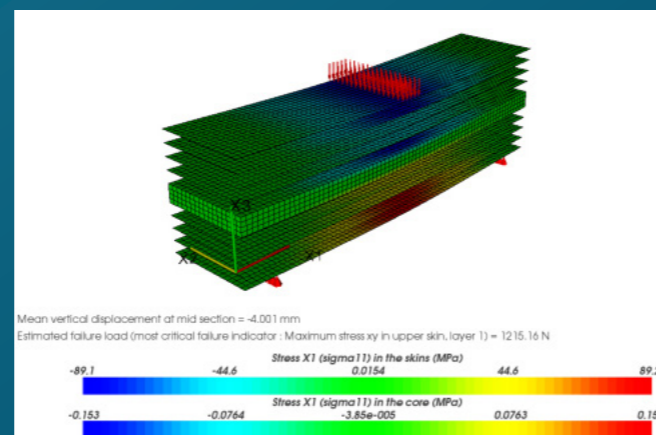

Stress response of a composite sandwich panel exposed to three-point bending

FEA Model

- Automatic mesh generation following selected mesh refinement:
 - Coarse
 - Average
 - Fine
- Loading:
 - Three-point bending
 - Four-point bending
 - In-plane shear

Customized positions and amplitudes for loading points and fixations.

Core Definition

- Honeycomb: honeycomb properties are computed using micromechanical models based on the cell geometry and the bulk properties
- Foam

Post-processing

- Integrated post-processing including 3D and through-thickness views of stresses, strains and failure indicators.

Failure Indicators

- Core:
 - Maximum stress (compressive, shear)
- Skin:
 - Maximum stress
 - Tsai-Wu
 - Tsai-Hill
 - Azzi-Tsai-Hill

Automatic Report Generation (html)

Automatic Generation and Solving of the FEA

Model using a Built-in FEA Solver

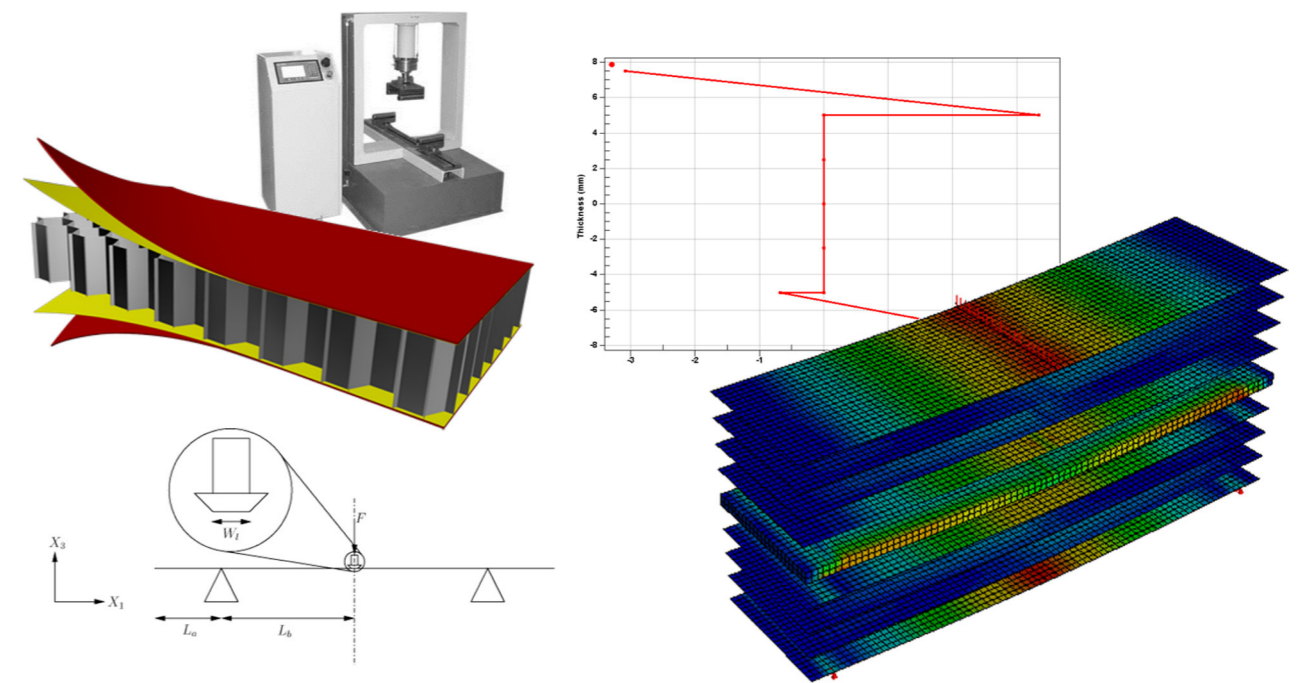

Digmat-HC – Virtual test environment for composite sandwich panels

Digmat-VA

Digmat-VA (“Virtual Allowables”) is an efficient solution that empowers engineers to virtually compare materials before going into the lengthy physical allowables. By generating virtual allowables, engineers can now start the component design in parallel to the physical allowable campaign.

Digmat-VA is a vertical solution is developed to compute, instead of test, the behavior of composite coupons (unnotched, open hole, filled hole, etc.) to screen, select and compute the allowables of composite materials.

Digmat-VA...

- It defines test matrix in a few clicks
- It creates multiscale material models based on composite datasheet
- It models batch and process variability
- It can go beyond recommended CMH17 procedures
- It turns a test matrix into FEA runs to obtain virtual allowables

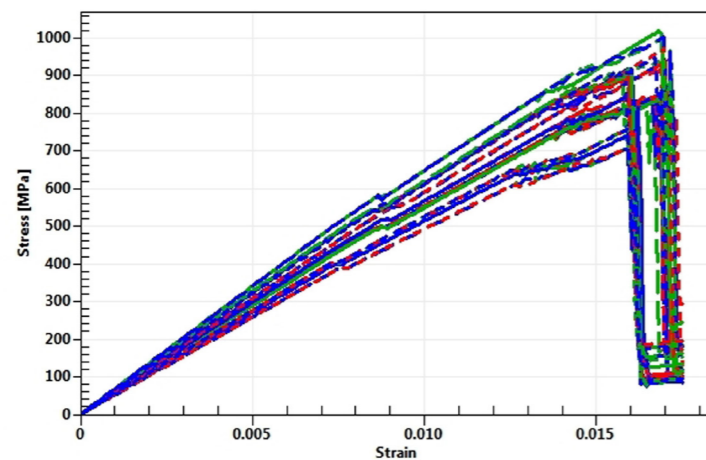

Figure 1: Stress-strain curves extracted from coupon simulations including variability

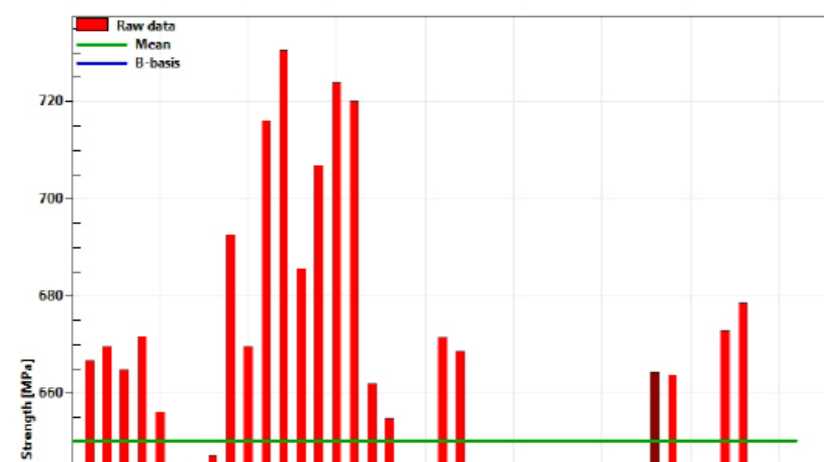

Figure 2: A and B-basis are computed from the raw strengths results

Latest Capabilities

- Modeling effects of defects over stiffness and strength:
 - Fiber waviness
 - Intra and inter-ply porosity
 - Gaps in AFP
 - Initial delamination
- Smart time-stepping for reduced CPU time.
- Sensitivity study over effects of defects.
- Command line mode.

Main Capabilities

- Prediction of allowables
 - UD, woven materials
 - Unnotched tension/compression, open-hole tension/compression tests, filled hole tension/compression and bearing tests
 - Test matrix preparation
 - Definition of materials, layups, tests, environment condition
 - Definition of variability (none, random draw, parametric study)
 - Simulation preparation
 - Import of Digmat model including progressive failure
 - Setup of user defined material model if needed
 - Calibration of Digmat model from data sheet (progressive failure or first ply failure)
 - Definition of micro-level variability
 - Gaussian distributions
 - Definition of FEA settings
 - Mesh size, element type, meshing strategy, number of timesteps
 - Generation of FEA models
 - Preview mesh
 - Preview random draws
- Simulation run
 - Embedded solver for local run
 - Remote job submission for large simulation test matrix
 - Job management
- Job prioritization
- Monitoring
- Post-processing
 - Automatic extraction of stress-strain curve, stiffness and strength
 - Computation of A, B-basis and mean values for strength following CMH17 procedures
 - Strength and stiffness distribution plots
 - Visualization of stress, strain and damage fields on coupon model, failure mode
 - Creation of a customized report
 - Export of raw results to Excel
 - Export of raw results to MaterialCenter
- Additional functionalities
 - Save Digmat-VA project
 - light or complete
 - Management of working database
 - materials, layups, tests, conditions and FEA settings

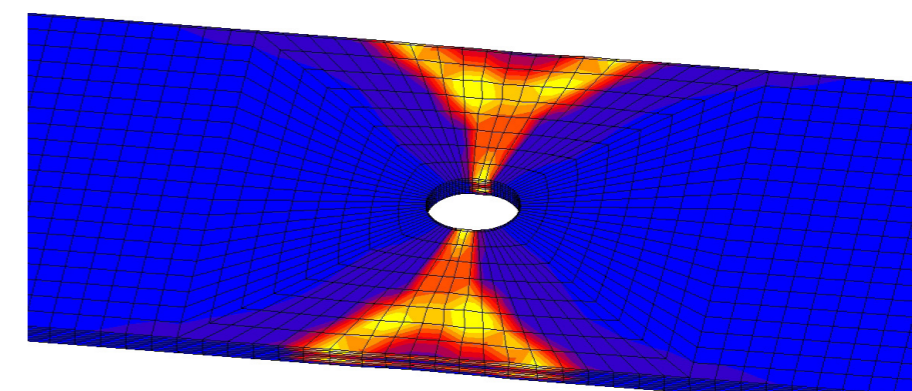

Figure 3: Visualization of fiber damage in an open-hole tension specimen

Digmat-AM

Digmat-AM is a process simulation solution dedicated to the Additive Manufacturing of polymer parts. It predicts the as-printed part warpage and residual stresses accounting for the process characteristics and material behaviors.

Digmat-AM provides engineers with a process simulation solution that helps:

- Minimize warpage and control shape
- Minimize part-to-part variability
- Set up the right manufacturing parameters for high precision printing

and further bridges the gap between printing process, material and part performances.

Latest Capabilities

- Explicit modeling of supports & brims
- Batch/command-line mode
- Costing model
- Improved usability for results post-processing (automated part superposition, scan comparison, ...)
- Support of FFF and FDM partial infill
- Support of full SLS build simulation
- Support of thermo-viscoelastic material model for polymer combined with transversely isotropic elastic model for fiber reinforcement.
- Database update (Stratasys, Domo, Roboze, Markforged)
- Voxelize part geometry
- Map the local printing directions to the voxel mesh

Main Capabilities

Supported AM processes:

- Selective Laser Sintering (SLS)*
- Fused Filament Fabrication (FFF) or Fused Deposition Modeling (FDM)

Simulation setup

- Select printer or define printer characteristics (Stratasys Fortus 900mc available)
- Load part geometry (STL format)
- Position the part in the printer chamber
- Load and visualize toolpath (GCode file format when targeting FDM/FFF, Insight file when targeting FDM)
- Import material model from Digmat-MX database (or create a generic one)
- Support unfilled and reinforced materials (beads and fibers reinforcements)
- Voxelize part geometry

Finite element analysis

- Embedded non-linear solver (standalone solution)
- Thermo-mechanical simulations
- Job management and monitoring

Post-processing

- Prediction of warpage and residual stresses
- Field visualization (stresses, displacements)
- Warpage visualization
- Export results and voxel mesh
- Export deformed STL file

Project management

- Load/Save Digmat-AM project

- Map the local printing directions to the voxel mesh

Finite element analysis

- Embedded non-linear solver (standalone solution)
- Thermo-mechanical simulations
- Job management and monitoring

Post-processing

- Prediction of warpage and residual stresses
- Field visualization (stresses, displacements)
- Warpage visualization
- Export results and voxel mesh
- Export deformed STL file

Project management

- Load/Save Digmat-AM project

Digmat-AM workflow reproduces the real printing process:

- Choose the printing technology (SLS or FDM/FFF)
- Select the printer from a dedicated database with predefined parameters, or specify user-defined parameters
- Load the part geometry in STL format
- Load the slicing or toolpath definition
- Select the material grade (reinforced or unfilled polymer) and the associated material model from Digmat-MX database
- Create the voxel mesh of the part
- Solve the thermo-mechanical finite element analysis simulating the printing process
- Post-process and export the results of the process simulation (stress/strain fields, warped part shape, etc.)
- Optimize the process parameters

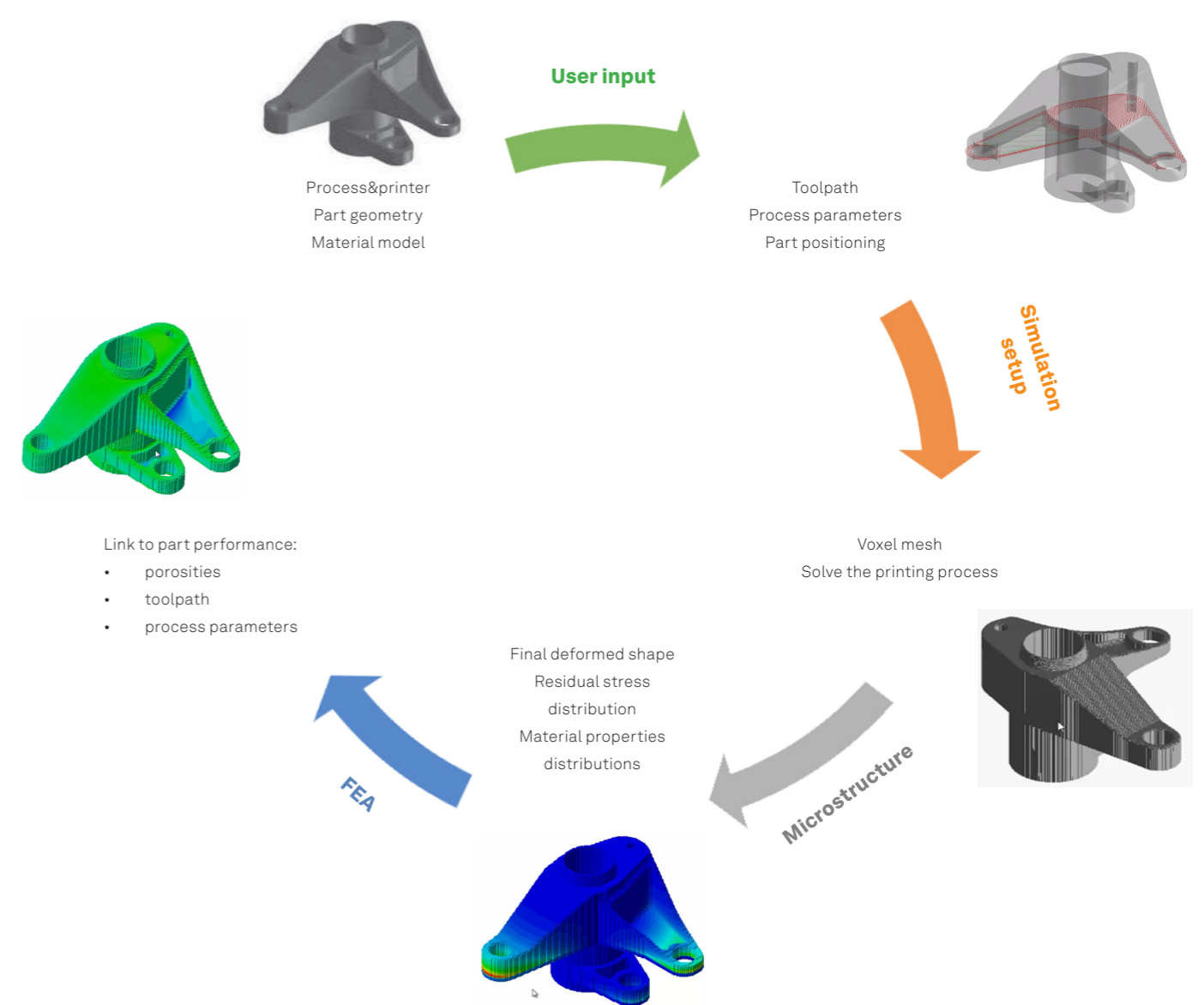

Training

e-Xstream engineering provides a complete training service with the Digimat software package. The aim is to unlock the full power of the Digimat software with trainings created and led by product experts.

Digmat trainings are organized regularly in Europe, the USA, and Asia. The training offer includes Beginner and Advanced levels targeting the topics of Material Engineering (focus on Digimat-MF, Digimat-FE and Digimat-MX), Virtual Testing (focus on Digimat-VA, Digimat-MF and Digimat-FE), Structural Engineering (focus on Digimat-RP, Digimat-MAP, Digimat-CAE and Digimat-MX, etc.) and Process Simulation (focus on Digimat-AM).

These training courses are a combination of presentations and live product demos followed by practical hands-on sessions. They aim at answering the users' questions and also include the best practices on how to use Digimat new capabilities.

e-Xstream engineering also offers customized trainings, 100% tailored to the customers' specific needs and organized at the customer premises. These trainings are a combination of theory and product presentation followed by an assisted hands-on session. Besides general training and technology transfer the aim is to directly set-up customer specific models.

Contact our Training Services team at digmat.support@mscsoftware.com.

Engineering Services

The pressure for achieving major weight reductions has been around for a few years and keeps increasing. A solution to most industries consists in innovating on the use of composites in applications known to be restricted to other materials such as metals. For other industries, composites are already used extensively but a lack of control on their exact properties limit users' ability to optimize designs and develop new composite solutions. Virtual prototyping is absolutely necessary to efficiently drive, with confidence, those types of engineering innovations; it serves at fully understanding and mastering both the processing of composite parts as well as their end performances.

Thanks to the Digimat technology that plays a key role in accurately modeling composite materials and parts in the virtual prototyping phase, the product development process is accelerated and products design is optimized. But having access to the right products isn't always sufficient; it is important to understand when and how to use it, as well as to render it user-friendly via the elaboration of clear and straightforward procedures helping anyone in the company to use Digimat in its daily life.

With more than 15 years of experience in the field of composites modeling, e-Xstream is composed of an extremely skilled engineering team with broad knowledge and expertise in various types of engineering disciplines across all industries.

Areas of eXpertise :

Process simulation: Injection and compression molding, drape molding, RTM, etc.

Structural simulation: Static, Dynamic (impact & crash), Modal, Fatigue, Creep, etc.

Various industries: Aerospace, Automotive, Consumer Electronics, Material Suppliers, etc.

Various CAE softwares: MSC software, Abaqus, Altair, ANSYS, Autodesk Moldflow, LS-Dyna, PAM-CRASH, RADIOSS and SAMCEF.

Thanks to this outstanding team, e-Xstream is proud to offer consulting support, for any type of composite engineering work, based on your specific needs and requirements. This could range from performing analysis for you on a project basis; one or two times a year, or providing full time staff members to help you create repeatable processes in-house.

The Engineering Services team works closely with customers to support their specific needs in getting more accurate predictions of the micro-mechanical behavior of composite materials and parts.

Contact our Engineering Services team at engineering.services@e-Xstream.com



Hexagon is a global leader in sensor, software and autonomous solutions. We are putting data to work to boost efficiency, productivity, and quality across industrial, manufacturing, infrastructure, safety, and mobility applications.

Our technologies are shaping urban and production ecosystems to become increasingly connected and autonomous – ensuring a scalable, sustainable future.

e-Xstream engineering, part of Hexagon's Manufacturing Intelligence division, provides Integrated Computational Materials Engineering (ICME) solutions to innovate and optimise product performance using the right materials and manufacturing process for the right application. Learn more at [e-Xstream.com](https://www.e-xstream.com). Hexagon's Manufacturing Intelligence division provides solutions that utilise data from design and engineering, production and metrology to make manufacturing smarter.

Learn more about Hexagon (Nasdaq Stockholm: HEXA B) at [hexagon.com](https://www.hexagon.com) and follow us [@HexagonAB](https://twitter.com/HexagonAB).



SIGMA
Solutions
Integrated Engineering Simulation Technology

Sigma Solutions Co., Ltd.
77/95, Sinn Sathorn Tower, 23rd Floor,
Krungthongburi Road, Klongsan, Bangkok 10600, Thailand.
Tel: +66 2862 1188 Fax: +66 2862 2405
email: sales@sigmasolutions.co.th
www.sigmasolutions.co.th
facebook.com/SigmaThailand
Line ID: @sigmasolutions